



# Full Accurate 14/16 Bit Vout *nanoDAC*<sup>TM</sup>, Buffered, 3V/5V, Sot 23

Preliminary Technical Data

**AD5040/AD5060**

## FEATURES

- Single 14/16-Bit DAC, 1 Lsb inl.
- Power-On-Reset to Zero Volts/Mid Scale
- Three Power-Down Functions
- Low Power Serial Interface with Schmitt-Triggered Inputs
- 8-Lead Sot23
- Low Power Operation
- Fast Settling.
- Low Glitch on Powerup.

## APPLICATIONS

- Process Control
- Data Acquisition Systems
- Portable Battery Powered Instruments
- Digital Gain and Offset Adjustment
- Programmable Voltage and Current Sources
- Programmable Attenuators

## GENERAL DESCRIPTION

The AD5040/AD5060, members of the *nanoDAC*<sup>TM</sup> family, are single 14/16-bit buffered voltage out DACs. Both parts are available in a 8ld Sot23. The AD5040 can be operated from 2.7-5.5V and the AD5060 can be operated at 3V/5V.

The part utilizes a versatile three-wire serial interface that operates at clock rates up to 30 MHz and is compatible with standard SPI<sup>TM</sup>, QSPI<sup>TM</sup>, MICROWIRE<sup>TM</sup> and DSP interface standards.

The reference for the AD5040/AD5060 is supplied from an external REF pin. A reference buffer is also provided on chip. The parts incorporate a power-on-reset circuit that ensures that the DAC output powers up to zero volts/ mid scale and remains there until a valid write takes place to the device. The parts also contain a power-down feature that reduces the current consumption of the device to 50nA at 5 V and provides software selectable output loads while in power-down mode. The part is put into power-down mode over the serial interface. Total unadjusted error for the part is <1mV.

These parts also provide a very low glitch on power-up.

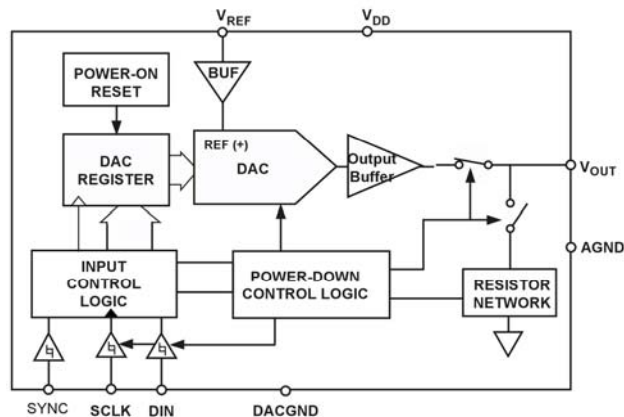

**AD5040/AD5060**

Part Number	Description
<b>AD5061</b>	2.7 V to 5.5 V, 16 Bit <i>nanoDAC</i> <sup>TM</sup> D/A, 4 LSBs INL, Buffered, Sot 23
<b>AD5062</b>	2.7 V to 5.5 V, 16 Bit <i>nanoDAC</i> <sup>TM</sup> D/A, 1 LSBs INL., Unbuffered, Sot 23.
<b>AD5063</b>	2.7 V to 5.5 V, 16 Bit <i>nanoDAC</i> <sup>TM</sup> D/A, 1 LSBs INL., Unbuffered, 10 uSOIC, uncommitted bi-polar resistors.

## PRODUCT HIGHLIGHTS

1. Available in 8-lead SOT23.
2. 16 Bit Accurate, 1 LSB INL.
3. Low Glitch on Power-up.
4. High speed serial interface with clock speeds up to 30 MHz.
5. Three power down modes available to the user.

## Rev. PrE

Information furnished by Analog Devices is believed to be accurate and reliable. However, no responsibility is assumed by Analog Devices for its use, nor for any infringements of patents or other rights of third parties that may result from its use. Specifications subject to change without notice. No license is granted by implication or otherwise under any patent or patent rights of Analog Devices. Trademarks and registered trademarks are the property of their respective owners.

One Technology Way, P.O. Box 9106, Norwood, MA 02062-9106, U.S.A.  
Tel: 781.329.4700 [www.analog.com](http://www.analog.com)  
Fax: 781.326.8703 © 2005 Analog Devices, Inc. All rights reserved.

AD5040/AD5060—SPECIFICATIONS<sup>1</sup>AD5040,  $V_{DD} = 3.3V$ ,  $V_{ref} = 3.0V$ . AD5060,  $V_{DD} = 5.5V$ ,  $V_{ref} = 4.096V$ ,  $R_L = 5k$ ,  $200pF$ .  $T_{MIN}$  to  $T_{MAX}$ ; unless otherwise noted.

Parameter	B Version <sup>1</sup>			Unit	Test Conditions/Comments
	Min	Typ	Max		
STATIC PERFORMANCE					
AD5040/AD5060 Resolution	16			Bits	
Relative Accuracy			$\pm 1$	LSB	
TUE		0.2	0.5	mV	
Differential Nonlinearity			$\pm 1$	LSB	Guaranteed Monotonic by Design.
Offset Error		+ 0.1	+ 0.3	mv	Code 160 loaded to Dac reg
Full scale Error		+/- 1.5		mv	All 1's loaded to Dac reg
Zero code Error		0.7	1.5	mv	All 0's loaded to Dac reg
offset code Error Drift		2		$\mu V/^{\circ}C$	
Gain Error		0.005	0.01	%FSR	
Gain Temperature Coefficient		2.5		ppm of FSR/ $^{\circ}C$	
OUTPUT CHARACTERISTICS					
Output Voltage Range	0		$V_{ref} - 50mV$	V	Unloaded. See plot for loaded condition (sink/source.)
Output Voltage Settling Time		10		$\mu s$	$1/4$ code to $3/4$ code
Slew Rate		1		V/ $\mu s$	
Capacitive Load Stability		470		pF	$R_L = \infty$
		1000		pF	$R_L = 5K$
Output Noise Spectral Density		60		nV/ $\sqrt{Hz}$	DAC code= $1/4$ scale , 1kHz
		60		nV/ $\sqrt{Hz}$	DAC code= $1/4$ scale , 10kHz
Digital-to-Analog Glitch Impulse		5		nV-s	1LSB Change Around Major Carry.
Digital Feedthrough		0.5		nV-s	
DC Output Impedance		0.1		$\Omega$	
REFERENCE INPUT/OUTPUT					
$V_{ref}$ Input Range	2		$V_{DD} - 50mV$	V	
Input Current		1		$\mu A$	
DC Input Impedance		1		M $\Omega$	
LOGIC INPUTS					
Input Current			$\pm 1$	$\mu A$	
$V_{INL}$ , Input Low Voltage	0.8			V	$V_{DD} = +2.7$ to $+5 V$
$V_{INH}$ , Input High Voltage			2.0	V	$V_{DD} = +2.7$ to $+5 V$
Pin Capacitance		3		pF	
POWER REQUIREMENTS					

Parameter	B Version <sup>1</sup>			Unit	Test Conditions/Comments
	Min	Typ	Max		
$V_{DD}$ $I_{DD}$ (Normal Mode) $V_{DD} = +2.7\text{ V to }+3.6\text{ V}$ $I_{DD}$ (All Power-Down Modes)	2.7		3.6	V	AD5060 (3 Volt Option) DAC Active and Excluding Load Current $V_{IH} = V_{DD}$ and $V_{IL} = \text{GND}$
$V_{DD}$ $I_{DD}$ (Normal Mode) $V_{DD} = +5.0\text{ V to }+5.5\text{ V}$ $I_{DD}$ (All Power-Down Modes)	5.0	900	5.5	$\mu\text{A}$	AD5060 (5 Volt Option) DAC Active and Excluding Load Current $V_{IH} = V_{DD}$ and $V_{IL} = \text{GND}$
$V_{DD}$ $I_{DD}$ (Normal Mode) $V_{DD} = +2.7\text{ V to }+5.5\text{ V}$ $I_{DD}$ (All Power-Down Modes)	5.0	1.3	5.5	mA	AD5060 (5 Volt Option) DAC Active and Excluding Load Current $V_{IH} = V_{DD}$ and $V_{IL} = \text{GND}$
$V_{DD}$ $I_{DD}$ (Normal Mode) $V_{DD} = +2.7\text{ V to }+5.5\text{ V}$ $I_{DD}$ (All Power-Down Modes)	2.7	1.3	5.5	V	AD5040 DAC Active and Excluding Load Current $V_{IH} = V_{DD}$ and $V_{IL} = \text{GND}$
$I_{DD}$ (Normal Mode) $V_{DD} = +2.7\text{ V to }+5.5\text{ V}$ $I_{DD}$ (All Power-Down Modes)		1.3		mA	AD5040 DAC Active and Excluding Load Current $V_{IH} = V_{DD}$ and $V_{IL} = \text{GND}$
Dc PSSR		0.25		LSB	VDD +/- 10% vdd = 5v , vref = 4.096v Dac set to midscale
Ac PSSR		0.5		LSB	VDD +/- 10% vdd = 3v , vref = 2.5v Dac set to midscale
		- 68		db	Vdd = 5v, onboard ref,@1khz Dac set to midscale
		- 68		db	Vdd = 3v, onboard ref,@1khz Dac set to midscale

NOTES

<sup>1</sup>Temperature ranges are as follows: B Version: -40°C to +125°C, typical at 25°C.

<sup>2</sup>Guaranteed by design and characterization, not production tested.

<sup>3</sup>Linearity calculated using a reduced code range 480-64716.  
Specifications subject to change without notice.

## TIMING CHARACTERISTICS

( $V_{DD} = 2.7-5.5\text{ V}$ ; all specifications  $T_{MIN}$  to  $T_{MAX}$  unless otherwise noted)

Parameter	Limit <sup>1</sup>		Unit	Test Conditions/Comments
$t_1^3$	33		ns min	SCLK Cycle Time
$t_2$	13		ns min	SCLK High Time
$t_3$	12		ns min	SCLK Low Time
$t_4$	13		ns min	SYNC to SCLK Falling Edge Setup Time
$t_5$	5		ns min	Data Setup Time
$t_6$	4.5		ns min	Data Hold Time
$t_7$	0		ns min	SCLK Falling Edge to SYNC Rising Edge
$t_8$	33		ns min	Minimum SYNC High Time
$t_9$	13		ns min	SYNC Rising Edge to next SCLK Fall Ignore

## NOTES

<sup>1</sup>All input signals are specified with  $t_r = t_f = 1\text{ ns/V}$  (10% to 90% of  $V_{DD}$ ) and timed from a voltage level of  $(V_{IL} + V_{IH})/2$ .

<sup>2</sup>See Figure 1.

<sup>3</sup>Maximum SCLK frequency is 30 MHz.

Specifications subject to change without notice.

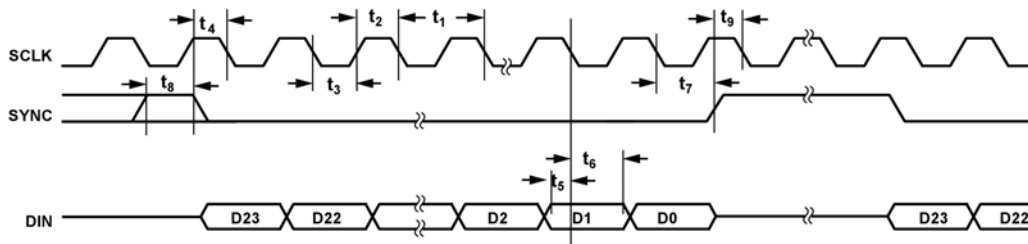

Figure 1. Timing Diagram AD5060. AD5040 has same timing specs with 14 bit Word.

## ABSOLUTE MAXIMUM RATINGS

Table 1. Absolute Maximum Ratings ( $T_A = 25^\circ\text{C}$  unless otherwise noted)

Parameter	Rating
$V_{DD}$ to GND	-0.3 V to + 7.0 V
Digital Input Voltage to GND	-0.3 V to $V_{DD} + 0.3$ V
$V_{OUT}$ to GND <sup>1</sup>	-0.3 V to $V_{DD} + 0.3$ V
Operating Temperature Range	
Industrial (B Version)	-40°C to +125°C
Storage Temperature Range	-65°C to +150°C
Maximum Junction Temperature	150°C
SOT23 Package	
Power Dissipation	$(T_j \text{ Max} - T_a) / \theta_{JA}$
$\theta_{JA}$ Thermal Impedance	229.6°C/W
$\theta_{JC}$ Thermal Impedance	91.99°C/W
Lead Temperature, Soldering	
Vapour Phase (60 Sec)	300°C
Infrared (15 Sec)	220°C

Stresses above those listed under Absolute Maximum Ratings may cause permanent damage to the device. This is a stress rating only; functional operation of the device at these or any other conditions above those listed in the operational sections of this specification is not implied. Exposure to absolute maximum rating conditions for extended periods may affect device reliability.

### ESD Caution

ESD (electrostatic discharge) sensitive device. Electrostatic charges as high as 4000 V readily accumulate on the human body and test equipment and can discharge without detection. Although this product features proprietary ESD protection circuitry, permanent damage may occur on devices subjected to high energy electrostatic discharges. Therefore, proper ESD precautions are recommended to avoid performance degradation or loss of functionality.



This device is a high performance RF integrated circuit with an ESD rating of <2 kV, and it is ESD sensitive. Proper precautions should be taken for handling and assembly.

Model	Temperature Range	INL	Description	Package Options
AD5060BRJ-1	-40°C to 125°C	1 LSB	5V, Reset to Zero	RT8
AD5060BRJ-1500RL7	-40°C to 125°C	1 LSB	5V, Reset to Zero	RT8
AD5060BRJ-1REEL7	-40°C to 125°C	1 LSB	5V, Reset to Zero	RT8
AD5060BRJ-2	-40°C to 125°C	1 LSB	5V, Reset to Mid	RT8
AD5060BRJ-2500RL7	-40°C to 125°C	1 LSB	5V, Reset to Mid	RT8
AD5060BRJ-2REEL7	-40°C to 125°C	1 LSB	5V, Reset to Mid	RT8
AD5060BRJ-3	-40°C to 125°C	1 LSB	3V, Reset to Zero	RT8
AD5060BRJ-3500RL7	-40°C to 125°C	1 LSB	3V, Reset to Zero	RT8
AD5060BRJ-3REEL7	-40°C to 125°C	1 LSB	3V, Reset to Zero	RT8
AD5060ARJ-1	-40°C to 125°C	2 LSB	5V, Reset to Zero	RT8
AD5060ARJ-1500RL7	-40°C to 125°C	2 LSB	5V, Reset to Zero	RT8
AD5060ARJ-1REEL7	-40°C to 125°C	2 LSB	5V, Reset to Zero	RT8
AD5060ARJ-2	-40°C to 125°C	2 LSB	5V, Reset to Mid	RT8
AD5060ARJ-2500RL7	-40°C to 125°C	2 LSB	5V, Reset to Mid	RT8
AD5060ARJ-2REEL7	-40°C to 125°C	2 LSB	5V, Reset to Mid	RT8
AD5060ARJ-3	-40°C to 125°C	2 LSB	3V, Reset to Zero	RT8
AD5060ARJ-3500RL7	-40°C to 125°C	2 LSB	3V, Reset to Zero	RT8
AD5060ARJ-3REEL7	-40°C to 125°C	2 LSB	3V, Reset to Zero	RT8
AD5040BRJZ	-40°C to 125°C	1LSB	2.7-5.5V, Reset to Zero	RT8
AD5040BRJZ – 500RL	-40°C to 125°C	1LSB	2.7-5.5V, Reset to Zero	RT8
AD5040BRJZ – REEL7	-40°C to 125°C	1 LSB	2.7-5.5V, Reset to Zero	RT8
EVAL-AD5040EB			AD5040 Evaluation Board	
EVAL-AD5060EB			AD5060 Evaluation Board	

# PIN CONFIGURATION AND FUNCTION DESCRIPTION

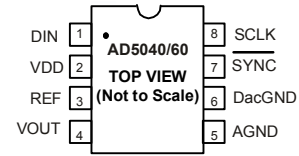

Figure 2. AD5040/60 8 Id SOT23

Table 2. Pin Function Descriptions

Mnemonic	Function
V <sub>DD</sub>	Power Supply Input. These parts can be operated from +2.5 V to +5.5 V and V <sub>DD</sub> should be decoupled to GND.
REF	Reference Voltage Input.
DacGND	Ground input to the DAC.
V <sub>OUT</sub>	Analog output voltage from DAC.
SYNC	Level triggered control input (active low). This is the frame synchronization signal for the input data. When SYNC goes low, it enables the input shift register and data is transferred in on the falling edges of the following clocks. The DAC is updated following the 16th clock cycle unless SYNC is taken high before this edge in which case the rising edge of SYNC acts as an interrupt and the write sequence is ignored by the DAC.
SCLK	Serial Clock Input. Data is clocked into the input shift register on the falling edge of the serial clock input. Data can be transferred at rates up to 30 MHz.
D <sub>IN</sub>	Serial Data Input. This device has a 24 bit shift register. Data is clocked into the register on the falling edge of the serial clock input.
AGND	Ground reference point for Analog circuitry on the part.

**TERMINOLOGY****Relative Accuracy**

For the DAC, relative accuracy or Integral Nonlinearity (INL) is a measure of the maximum deviation, in LSBs, from a straight line passing through the endpoints of the DAC transfer function. A typical INL vs. code plot can be seen in Figure 2.

**Differential Nonlinearity**

Differential Nonlinearity (DNL) is the difference between the measured change and the ideal 1 LSB change between any two adjacent codes. A specified differential nonlinearity of  $\pm 1$  LSB maximum ensures monotonicity. This DAC is guaranteed monotonic by design. A typical DNL vs. code plot can be seen in Figure 3.

**Zero-Code Error**

Zero-code error is a measure of the output error when zero code (0000Hex) is loaded to the DAC register. Ideally the output should be 0 V. The zero-code error is always positive in the AD5040/AD5060 because the output of the DAC cannot go below 0 V. It is due to a combination of the offset errors in the DAC and output amplifier. Zero-code error is expressed in mV. A plot of zero-code error vs. temperature can be seen in Figure 6.

**Full-Scale Error**

Full-scale error is a measure of the output error when full-scale code (FFFF Hex) is loaded to the DAC register. Ideally the output should be  $V_{DD} - 1$  LSB. Full-scale error is expressed in percent of full-scale range. A plot of full-scale error vs. temperature can be seen in Figure 6.

**Gain Error**

This is a measure of the span error of the DAC. It is the deviation in slope of the DAC transfer characteristic from ideal expressed as a percent of the full-scale range.

**Total Unadjusted Error**

Total Unadjusted Error (TUE) is a measure of the output error taking all the various errors into account. A typical TUE vs. code plot can be seen in Figure 4.

**Zero-Code Error Drift**

This is a measure of the change in zero-code error with a change in temperature. It is expressed in  $\mu\text{V}/^\circ\text{C}$ .

**Gain Error Drift**

This is a measure of the change in gain error with changes in temperature. It is expressed in (ppm of full-scale range)/ $^\circ\text{C}$ .

**Digital-to-Analog Glitch Impulse**

Digital-to-analog glitch impulse is the impulse injected into the analog output when the input code in the DAC register changes state. It is normally specified as the area of the glitch in nV secs and is measured when the digital input code is changed by

1 LSB at the major carry transition (7FFF Hex to 8000 Hex). See Figure 19.

**Digital Feedthrough**

Digital feedthrough is a measure of the impulse injected into the analog output of the DAC from the digital inputs of the DAC but is measured when the DAC output is not updated. It is specified in nV secs and measured with a full-scale code change on the data bus, i.e., from all 0s to all 1s and vice versa.



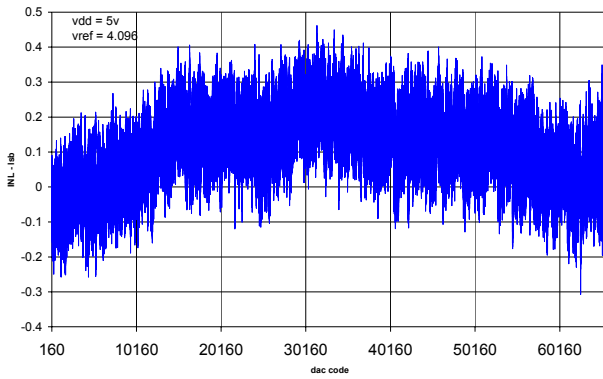

Figure 3. Typical INL Plot

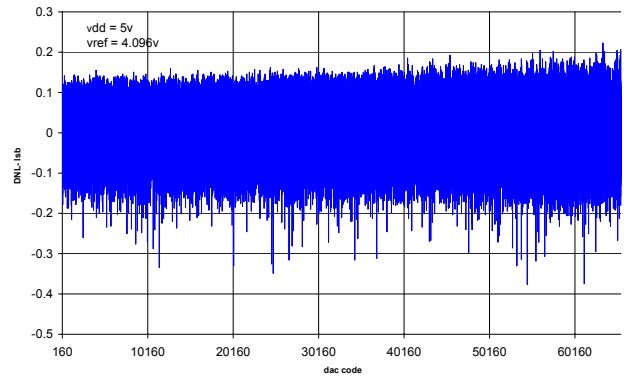

Figure 6. Typical DNL Plot.

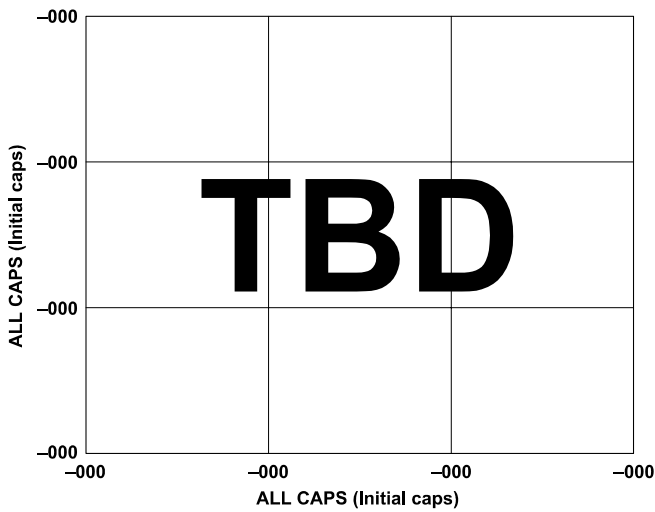

Figure 4. Total Unadjusted Error Polt.

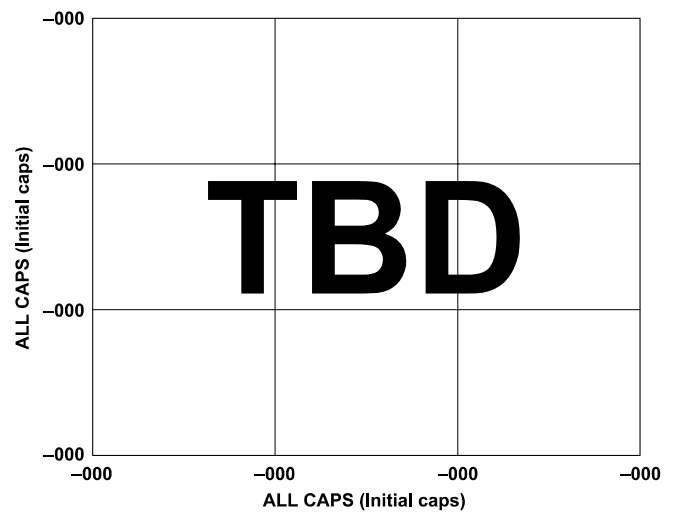

Figure 7. INL & DNLvs Supply

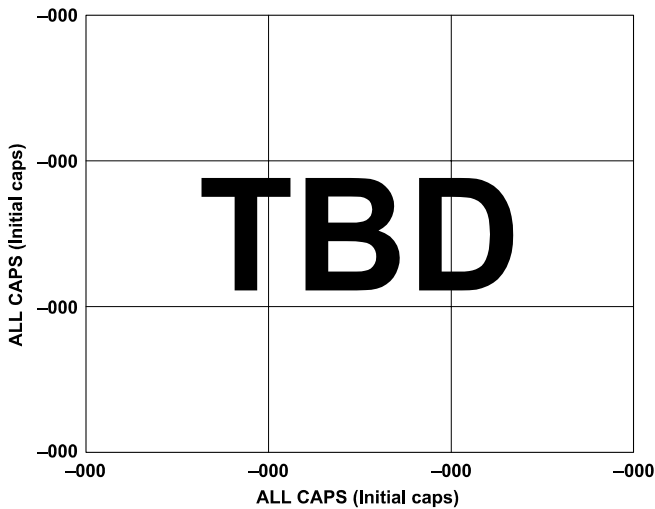

Figure 5. Zero Scale Error and Full Scale Error vs. Temperature

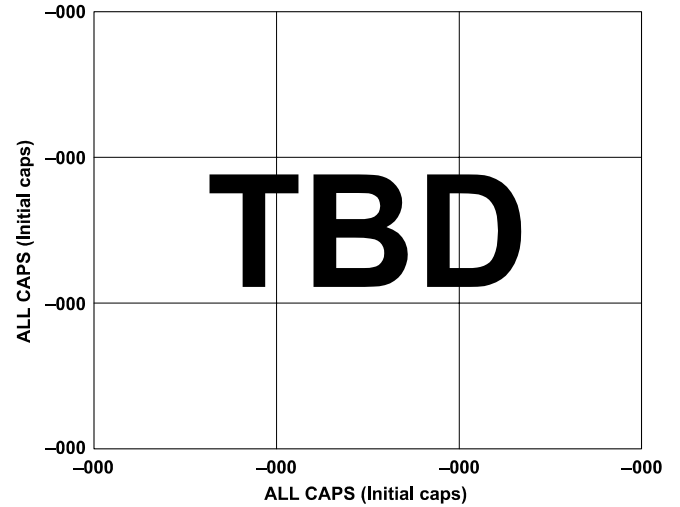

Figure 8. Idd Histogram @ Vdd=3/5 Volts.

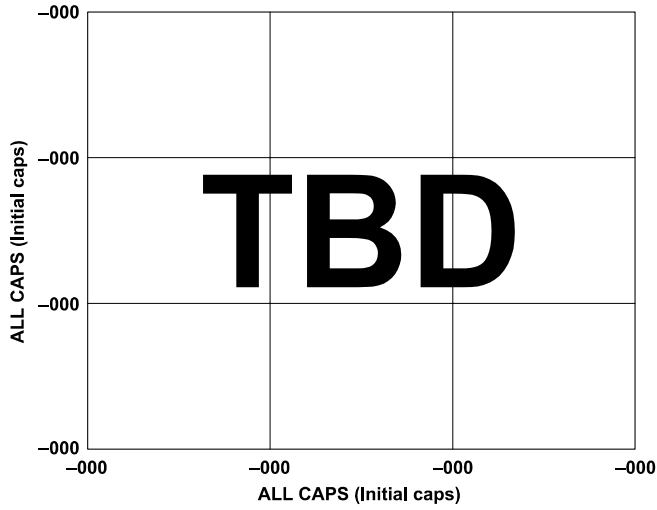

Figure 9. Source and Sink Current Capability

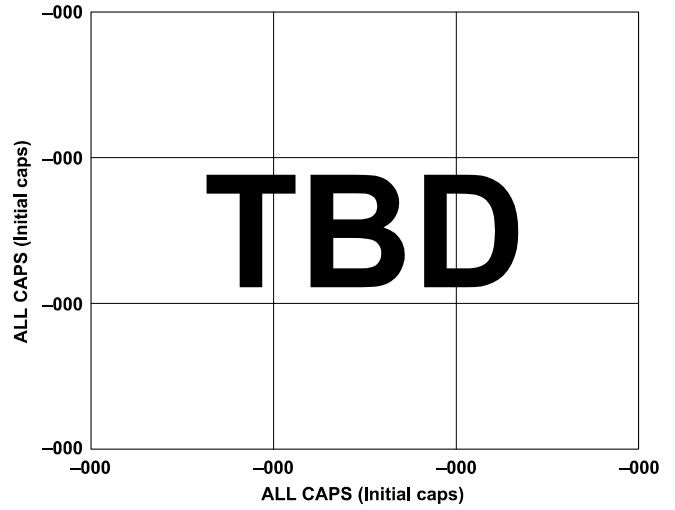

Figure 12. Supply Current vs Code.

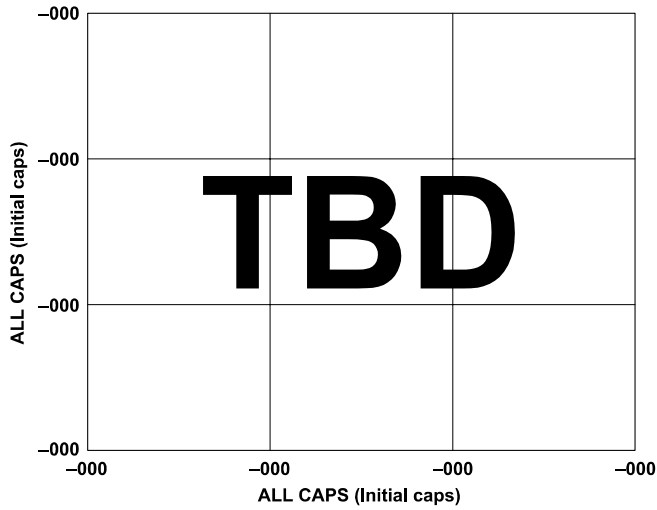

Figure 10. Supply Current vs. Temperature

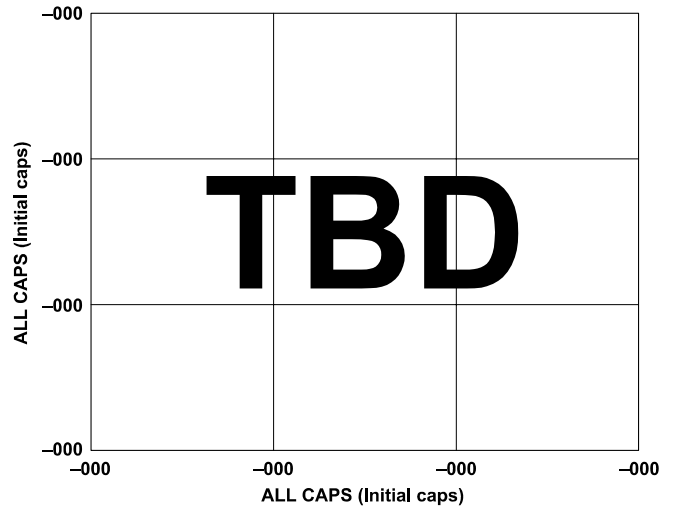

Figure 13. Supply Current vs Supply Voltage

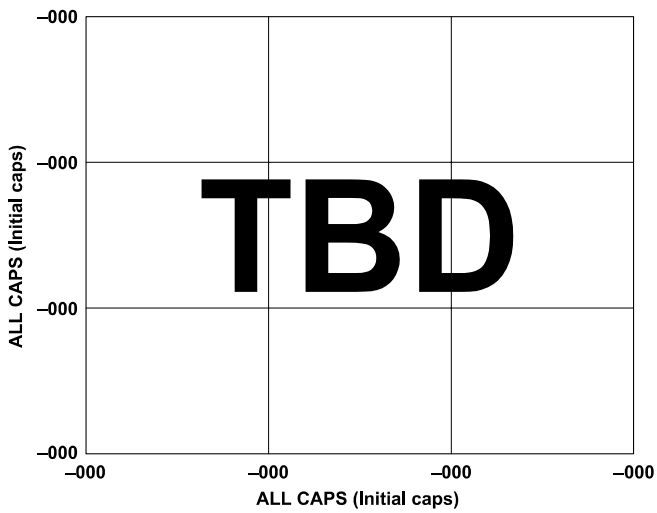

Figure 11. Full Scale Settling Time or 1/4 to 3/4 settling time (cc)

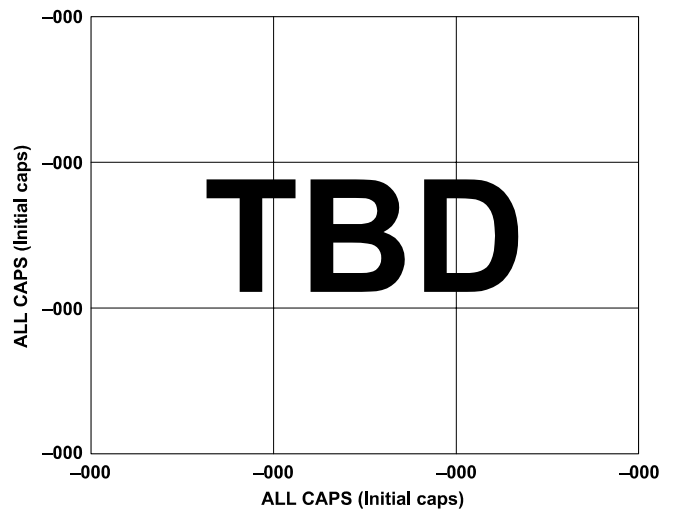

Figure 14 load regulation (cc)

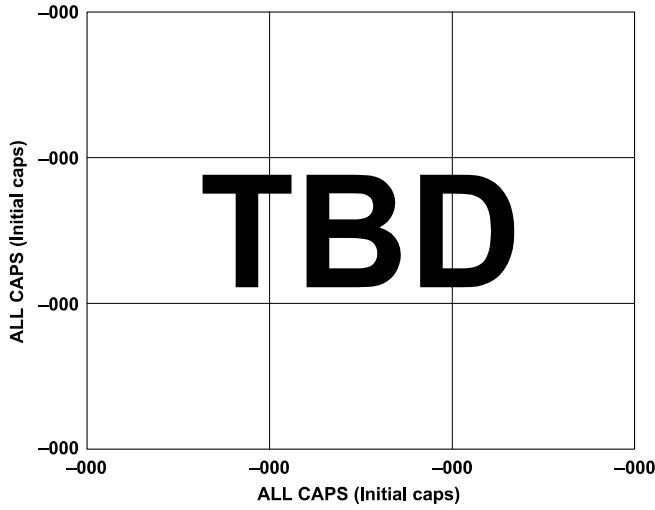

Figure 15. Power on Reset to 0 Volts.

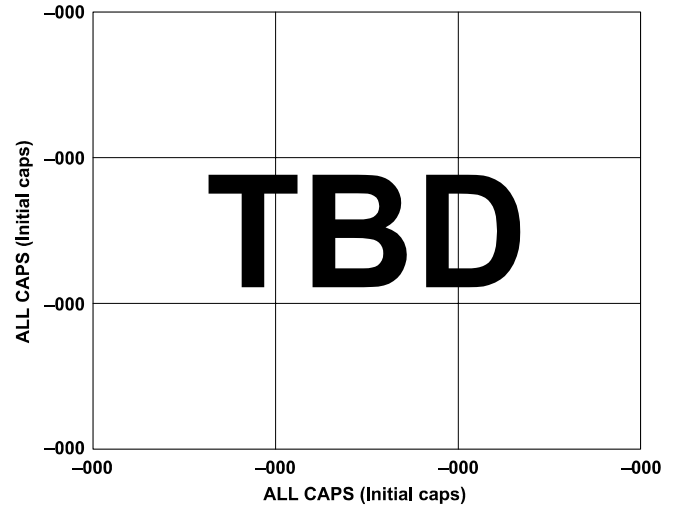

Figure 18. Exiting Power-Down

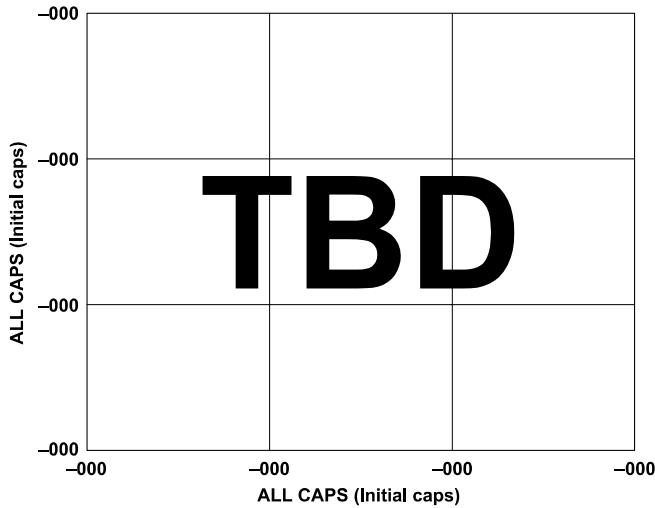

Figure 16. Digital to Analog Glitch Impulse

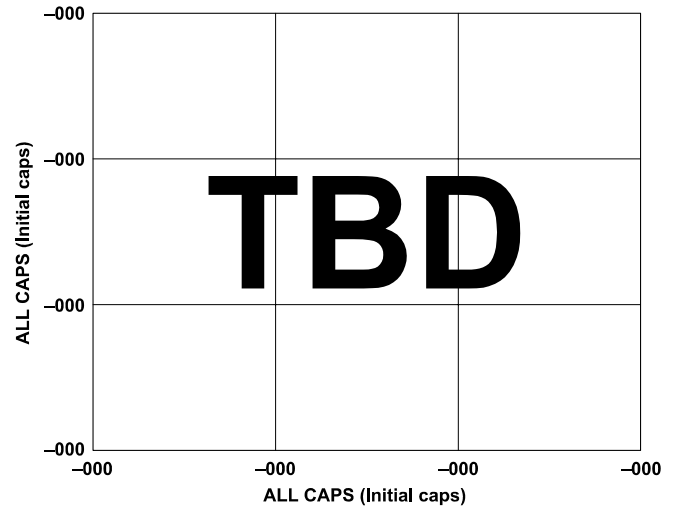

Figure 19. Harmonic Distortion on digitally Generated Waveform.

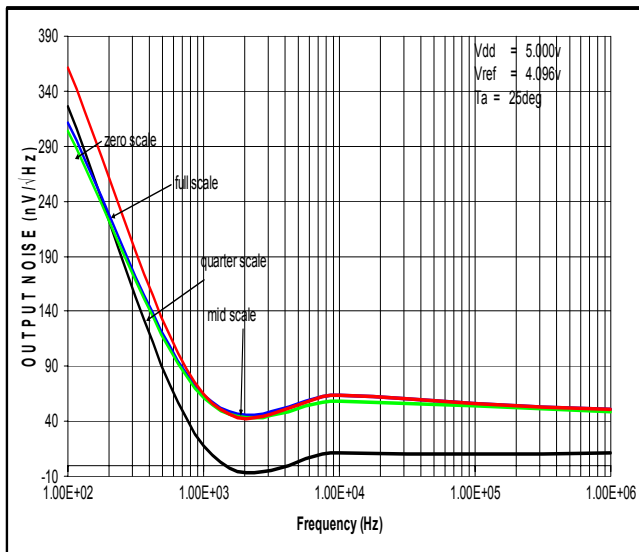

Figure 17. Output Spectral Density 1000k Bandwidth

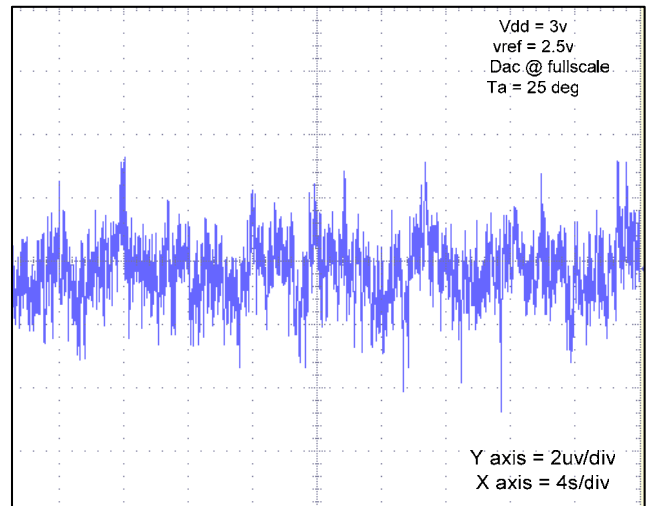

Figure 20. 0.1 Hz to 10 Hz Noise Plot

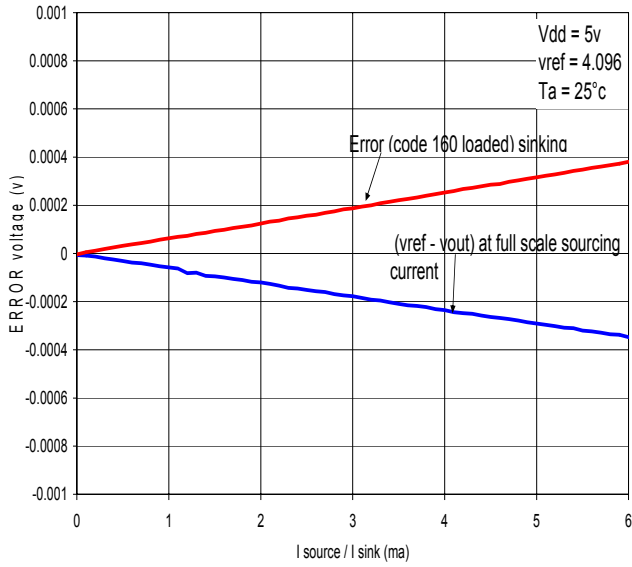

Figure 21. headroom at rails vs source /sink current

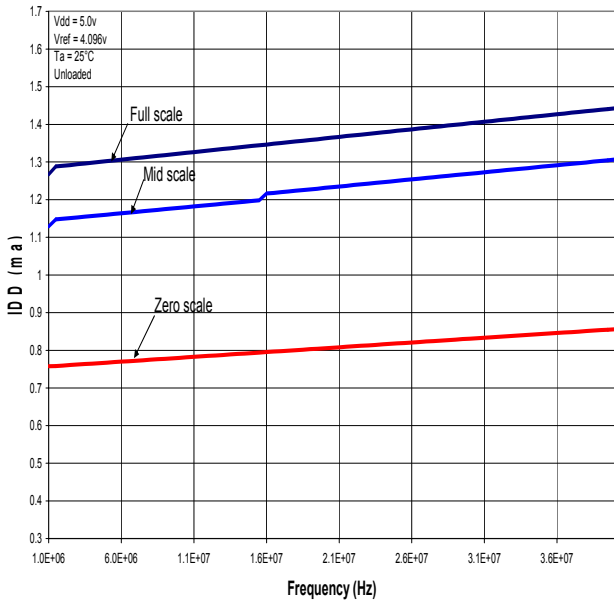

Figure 22. idd vs sclk

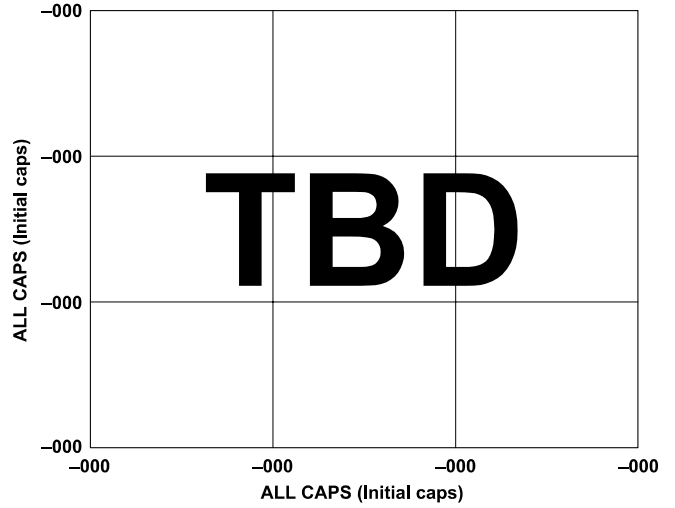

Figure 23. Offset Error Distribution

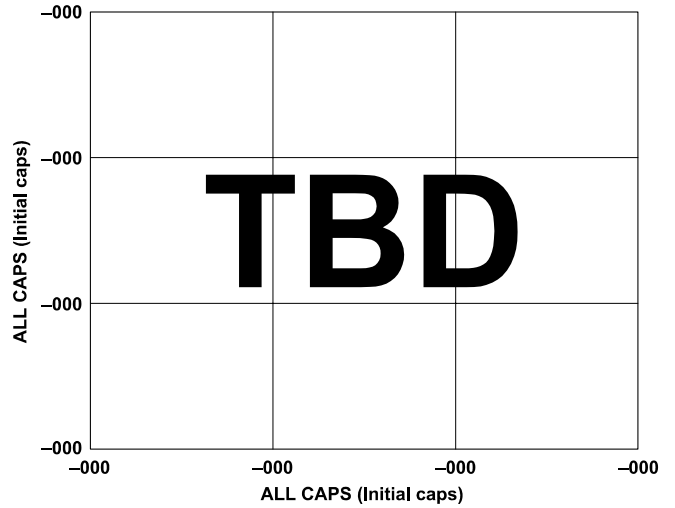

Figure 24. Gain Error Distribution

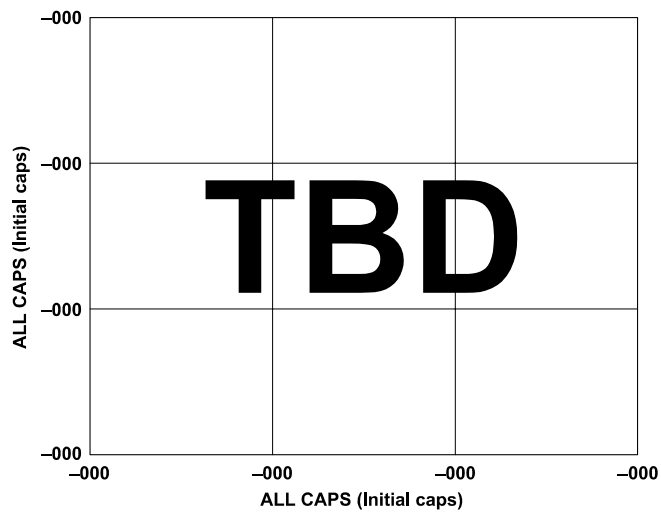

Figure 25. amplifier current sink /source capability (CC)

## GENERAL DESCRIPTION

The AD5040/AD5060 are single 14/16-bit, serial input, voltage output DACs. The AD5040 operates from a supply voltage of 2.7-5.5 V. The AD5060 operates from either a 3V or 5V supply. Data is written to the AD5040 in a 14-bit word format and to the AD5060 with a 16-bit word via a 3-wire serial interface

The AD5040/AD5060 incorporates a power-on reset circuit, which ensures that the DAC output powers up to 0 V or mid-scale. The device also has a software power-down mode pin, which reduces the typical current consumption to 50nA at 3V.

## DAC Architecture

The DAC architecture of the AD5040/AD5060 consists of two matched DAC sections. A simplified circuit diagram is shown in Figure X. The four MSBs of the 16-bit data word are decoded to drive 15 switches, E1 to E15. Each of these switches connects one of 15 matched resistors to either AGND or VREF. The remaining 12 bits of the data word drive switches S0 to S11 of a 12-bit voltage mode R-2R ladder network.

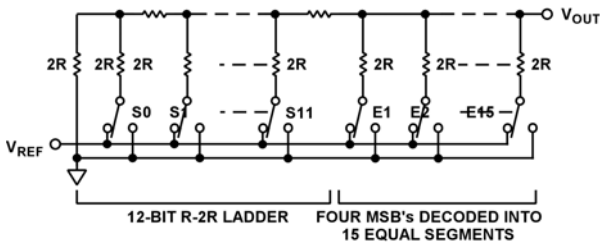

Figure X. DAC Ladder Structure

## Reference Buffer

The AD5040/60 operates with an external reference. The reference input (REFIN) has an input range of up to Vdd. This input voltage is then used to provide a buffered reference for the DAC core

## SERIAL INTERFACE

The AD5040/AD5060 (16/24 bit word write) have a three-wire serial interface (SYNC, SCLK and DIN), which is compatible with SPI, QSPI and MICROWIRE interface standards as well as most DSPs. See Figure 1 for a timing diagram of a typical write sequence.

The write sequence begins by bringing the SYNC line low. Data from the DIN line is clocked into the 16/24-bit shift register on the falling edge of SCLK. The serial clock frequency can be as high as 30 MHz, making these parts compatible with high speed DSPs. On the 16<sup>th</sup>/24<sup>th</sup> falling clock edge, the last data bit is clocked in and the programmed function is executed (i.e., a change in DAC register contents and/or a change in the mode of operation). At this stage, the SYNC line may be kept low or be brought high. In either case, it must be brought high for a minimum of 33 ns before the next write sequence so that a falling edge of SYNC can initiate the next write sequence. Since the SYNC buffer draws more current when V<sub>IN</sub> = 1.8 V than it does when V<sub>IN</sub> = 0.8 V, SYNC should be idled low between write sequences for even lower power operation of the part. As is mentioned above, however, it must be brought high again just before the next write sequence.

## Input Shift Register

The input shift register is 16/24 bits wide (see Figure 22/23). D23-D16 are set to zero for normal operation in the AD5060. For the AD5060 D17, D16 are control bits that control which mode of operation the part is in (normal mode or any one of three power-down modes). There is a more complete description of the various modes in the Power-Down Modes section. The next sixteen bits are the data bits. These are transferred to the DAC register on the 24<sup>th</sup> falling edge of SCLK.

For the AD5040 D15, D14 are control bits that control which mode of operation the part is in (normal mode or any one of three power-down modes). The next fourteen bits are the data bits. These are transferred to the DAC register on the 16<sup>th</sup> falling edge of SCLK.

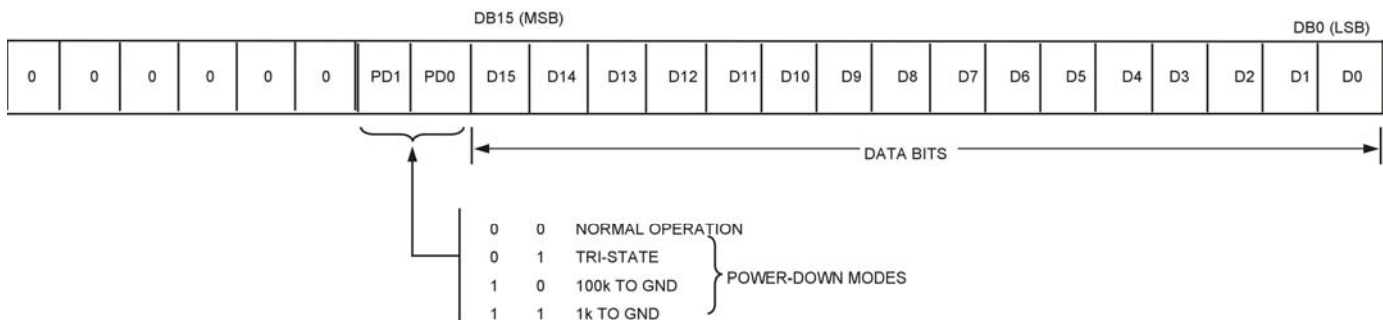

Figure 22. AD5060 Input Register Contents

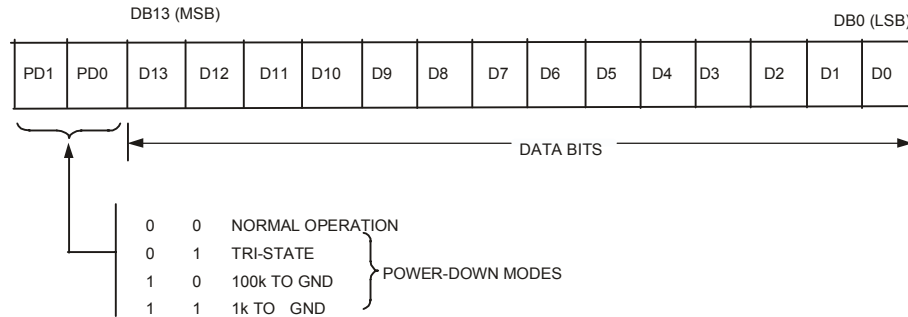

Figure 22. AD5040 Input Register Contents

### SYNC Interrupt

For the AD5060, in normal write sequence, the SYNC line is kept low for at least 24 falling edges of SCLK and the DAC is updated on the 24th falling edge. However, if SYNC is brought high before the 24th falling edge this acts as an interrupt to the write sequence. The shift register is reset and the write sequence is seen as invalid. Neither an update of the DAC register contents or a change in the operating mode occurs—see Figure 23. For the AD5040, the same applies to the 16<sup>th</sup> clock edge.

### Power-On-Reset

The AD5040/AD5060 contains a power-on-reset circuit that controls the output voltage during power-up. The DAC register is filled with zeros and the output voltage is zero volts/mid-scale. It remains there until a valid write sequence is made to the DAC. This is useful in applications where it is important to know the state of the output of the DAC while it is in the process of powering up.

### Software Reset.

The AD5040/AD5060 can be put into software reset by setting all bits in the Dac register to one. For the AD5060 this includes writing ones to bits D23-D16, which is not the normal mode of operation. **Note: The SYNC Interrupt command cannot be performed if a software reset command is started.**

### Power-Down Modes

The AD5040/AD5060 contains four separate modes of operation. These modes are software-programmable by setting two bits (PD1 and PD0) in the control register. Table I shows how the state of the bits corresponds to the mode of operation of the device.

Table I. Modes of Operation for the AD5040/AD5060

PD1	PD0	Operating Mode
0	0	Normal Operation Power-Down Mode
0	1	TRI-STATE
1	0	100 kΩ to GND
1	1	1 kΩ to GND *

\*Not available for the AD5040; Reserved mode.

When both bits are set to 0, the part works normally with its normal power consumption. However, for the three power-down modes, the supply current falls to 200 nA at 5 V (50 nA at 3 V). Not only does the supply current fall but the output stage is also internally switched from the output of the amplifier to a resistor network of known values. This has the advantage that the output impedance of the part is known while the part is in power-down mode.

There are three different options. The output is connected internally to GND through a 1kΩ resistor, a 100 kΩ resistor or it is left open-circuited (Three-State). The output stage is illustrated in

Figure 24.

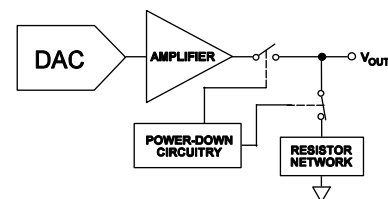

Figure 24. Output Stage During Power-Down

The bias generator, the output amplifier, the DAC and other associated linear circuitry are all shut down when the power-down mode is activated. However, the contents of the DAC register are unaffected when in power-down. The time to

exit power-down is typically 2.5  $\mu$ s for  $V_{DD} = 5$  V and 5  $\mu$ s for  $V_{DD} = 3$  V. See Figure 18 for a plot.

## MICROPROCESSOR INTERFACING AD5040/AD5060 to ADSP-2101/ADSP-2103 Interface

Figure 25 shows a serial interface between the AD5040/AD5060 and the ADSP-2101/ADSP-2103. The ADSP-2101/ADSP-2103 should be set up to operate in the SPORT Transmit Alternate Framing Mode. The ADSP-2101/ADSP-2103 SPORT is programmed through the SPORT control register and should be configured as follows: Internal Clock Operation, Active Low Framing, 16-Bit Word Length. Transmission is initiated by

writing a word to the Tx register after the SPORT has been enabled.

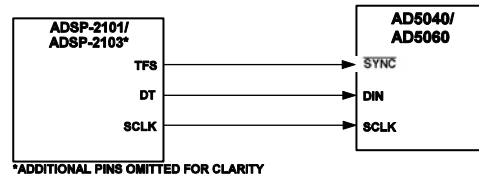

Figure 25. AD5040/AD5060 to ADSP-2101/ADSP-2103 Interface

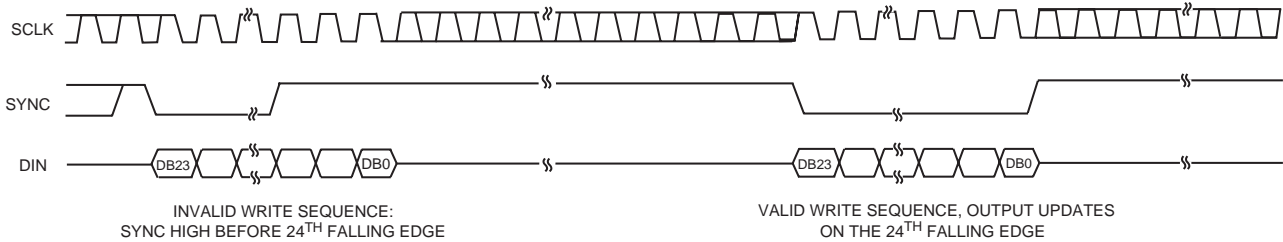

Figure 23. SYNC Interrupt Facility for AD5060.

## AD5040/AD5060 to 68HC11/68L11 Interface

Figure 26 shows a serial interface between the AD5060 and the 68HC11/68L11 microcontroller. SCK of the 68HC11/68L11 drives the SCLK of the AD5060, while the MOSI output drives the serial data line of the DAC. The SYNC signal is derived from a port line (PC7). The setup conditions for correct operation of this interface are as follows: the 68HC11/68L11 should be configured so that its CPOL bit is a 0 and its CPHA bit is a 1. When data is being transmitted to the DAC, the SYNC line is taken low (PC7). When the 68HC11/68L11 is configured as above, data appearing on the MOSI output is valid on the falling edge of SCK. Serial data from the 68HC11/68L11 is transmitted in 8-bit bytes with only eight falling clock edges occurring in the transmit cycle. Data is transmitted MSB first. In order to load data to the AD5040/AD5060, PC7 is left low after the first eight bits are transferred, and a second serial write operation is performed to the DAC and PC7 is taken high at the end of this procedure.

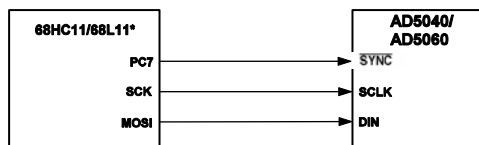

Figure 26. AD5040/AD5060 to 68HC11/68L11 Interface

## AD5040/AD5060 to Blackfin ADSP-BF53X Interface

Figure 2X shows a serial interface between the AD5060 and the Blackfin ADSP-53X microprocessor. The ADSP-BF53X processor family incorporates two dual-channel synchronous serial ports, SPORT1 and SPORT0 for serial and multiprocessor communications. Using SPORT0 to connect to the AD5062/63, the setup for the interface is as follows. DT0PRI drives the SDIN pin of the AD5062/63, while TSCLK0 drives the SCLK of the part. The SYNC is driven from TFS0.

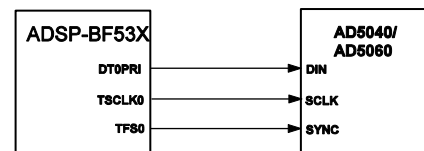

Figure 2X. AD5040/AD5060 to Blackfin ADSP-BF53X Interface

## AD5040/AD5060 to 80C51/80L51 Interface

Figure 27 shows a serial interface between the AD5040/AD5060 and the 80C51/80L51 microcontroller. The setup for the interface is as follows: TXD of the 80C51/80L51 drives SCLK of the AD5040/AD5060, while RXD drives the serial data line of the part. The SYNC signal is again derived from a bit programmable pin on the port. In this case port line P3.3 is used. When data is to be transmitted to the AD5040/AD5060,



P3.3 is taken low. The 80C51/80L51 transmits data only in 8-bit bytes; thus only eight falling clock edges occur in the transmit cycle. To load data to the DAC, P3.3 is left low after the first eight bits are transmitted, and a second write cycle is initiated to transmit the second byte of data. P3.3 is taken high following the completion of this cycle. The 80C51/80L51 outputs the serial data in a format which has the LSB first. The AD5040/AD5060 requires its data with the MSB as the first bit received. The 80C51/80L51 transmit routine should take this into account.

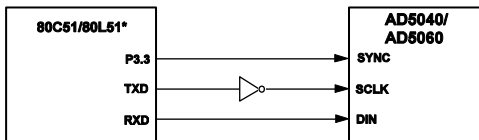

Figure 27. AD5040/AD5060 to 80C51/80L51 Interface

### AD5040/AD5060 to Microwire Interface

Figure 28 shows an interface between the AD5040/AD5060 and any microwire compatible device. Serial data is shifted out on the falling edge of the serial clock and is clocked into the AD5040/AD5060 on the rising edge of the SK.

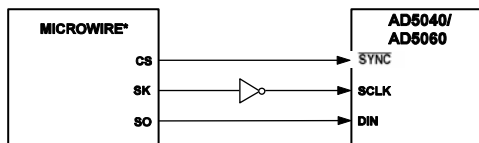

Figure 28. AD5040/AD5060 to MICROWIRE Interface

## APPLICATIONS

### Choosing a Reference for the AD5040/AD5060.

To achieve the optimum performance from the AD5060, thought should be given to the choice of a precision voltage reference. The AD5040/AD5060 have just one reference input, REFIN. The voltage on the reference input is used to supply the positive input to the Dac. Therefore any error in the reference will be reflected in the Dac.

There are 4 possible sources of error when choosing a voltage reference for high accuracy applications; initial accuracy, ppm drift, long term drift and output voltage noise. Initial accuracy on the output voltage of the Dac will lead to a full scale error in the Dac. To minimize these errors, a reference with high initial accuracy is preferred. Also, choosing a reference with an output trim adjustment, such as the ADR425 allow a system designer to trim system errors out by setting a reference voltage to a voltage other than the nominal. The trim adjustment can also be used at temperature to trim out any error.

Figure 29. ADR423 as Reference to AD5040. ADR420 can be used for AD5060.

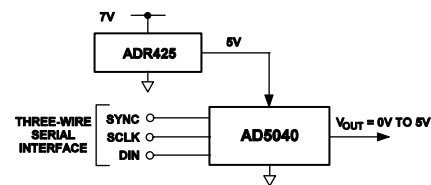

Long term drift is a measure of how much the reference drifts over time. A reference with a tight long term drift specification ensures that the overall solution remains relatively stable during its entire lifetime.

The temperature co-efficient of a references output voltage affect INL,DNL TUE. A reference with a tight temperature co-efficient specification should be chosen to reduce temperatue dependence of the Dac output voltage on ambient conditions.

In high accuracy applications, which have a relatively low noise budget, reference output voltage noise needs to be considered. Choosing a reference with as low an output noise voltage as practical for the system noise resolution required is important. Precision voltage references such as the ADR435 produce low output noise in the 0.1-10Hz region. Examples of some recommended precision references for use as supply to the AD5060 are shown in the figure below..

### Part list of precision references for use with AD5040/AD5060.

Part No.	Initial Accuracy (mV max)	Temp Drift (ppm °C max)	0.1-10Hz Noise (uV p-p typ)
ADR420	+/-6	3	1.75
ADR425	+/-6	3	3.4
ADR02	+/-5	3	15
ADR395	+/-6	25	5

### Bipolar Operation Using the AD5040/AD5060

The AD5040/AD5060 has been designed for single-supply operation but a bipolar output range is also possible using the circuit in Figure 30. The circuit below will give an output voltage range of ±5 V. Rail-to-rail operation at the amplifier output is achievable using an AD820 or an OP295 as the output amplifier.

The output voltage for any input code can be calculated as follows:

$$V_o = \left[ V_{DD} \times \left( \frac{D}{65536} \right) \times \left( \frac{R1 + R2}{R1} \right) - V_{DD} \times \left( \frac{R2}{R1} \right) \right]$$

where  $D$  represents the input code in decimal (0–65535).  
 With  $V_{DD} = 5\text{ V}$ ,  $R_1 = R_2 = 10\text{ k}\Omega$ :

$$V_o = \left( \frac{10 \times D}{65536} \right) - 5\text{ V}$$

This is an output voltage range of  $\pm 5\text{ V}$  with 0000Hex corresponding to a  $-5\text{ V}$  output and 3FFF Hex corresponding to a  $+5\text{ V}$  output.

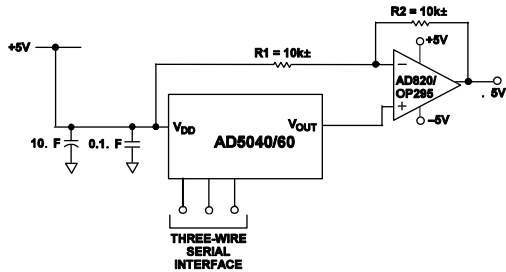

Figure 30. Bipolar Operation with the AD5040/AD5060

## Using AD5040/AD5060 with an Opto-Isolated Interface

In process-control applications in industrial environments it is often necessary to use an opto-isolated interface to protect and isolate the controlling circuitry from any hazardous common-mode voltages that may occur in the area where the DAC is functioning. Because the AD5040/AD5060 uses a three-wire serial logic interface, the ADuM130X family is an ideal way to provide digital isolation for the DAC interface.

The ADuM130x isolators provide three independent isolation channels in a variety of channel configurations and data rates. They operate across the full range from 2.7V to 5.5V, providing compatibility with lower voltage systems as well as enabling a voltage translation functionality across the isolation barrier.

Figure 31. The power supply to the part also needs to be isolated. This is done by using a transformer. On the DAC side of the transformer, a +5 V regulator provides the +5 V supply required for the AD5040/AD5060.

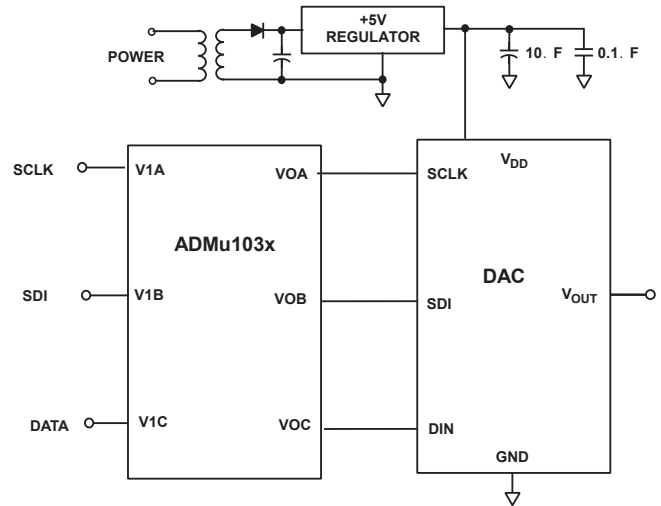

Figure 31. AD5040/AD5060 with An Opto-Isolated Interface

## Power Supply Bypassing and Grounding

When accuracy is important in a circuit it is helpful to carefully consider the power supply and ground return layout on the board. The printed circuit board containing the AD5040/AD5060 should have separate analog and digital sections, each having its own area of the board. If the AD5040/AD5060 is in a system where other devices require an AGND to DGND connection, the connection should be made at one point only. This ground point should be as close as possible to the AD5040/AD5060.

The power supply to the AD5040/AD5060 should be bypassed with

10  $\mu\text{F}$  and 0.1  $\mu\text{F}$  capacitors. The capacitors should be physically as close as possible to the device with the 0.1  $\mu\text{F}$  capacitor ideally right up against the device. The 10  $\mu\text{F}$  capacitors are the tantalum bead type. It is important that the 0.1  $\mu\text{F}$  capacitor has low Effective Series Resistance (ESR) and Effective Series Inductance (ESI), e.g., common ceramic types of capacitors. This 0.1  $\mu\text{F}$  capacitor provides a low impedance path to ground for high frequencies caused by transient currents due to internal logic switching.

The power supply line itself should have as large a trace as possible to provide a low impedance path and reduce glitch effects on the supply line. Clocks and other fast switching digital signals should be shielded from other parts of the board by digital ground. Avoid crossover of digital and analog signals if possible. When traces cross on opposite sides of the board, ensure that they run at right angles to each other to reduce feedthrough effects through the board. The best board layout technique is the microstrip technique where the component side of the board is dedicated to the ground plane only and the signal traces are placed on the solder side. However, this is not always possible with a two-layer board.

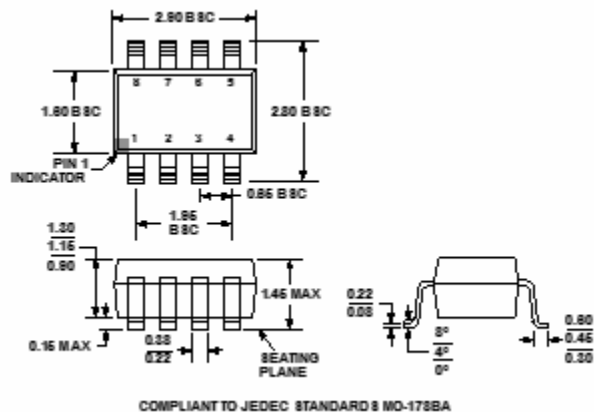

8 ld SOT23

**Outline Dimensions**

Dimensions shown in inches and mms